

Developing host resistance to thrips in chilli, a multilateral prebreeding approach

Research proposal

for

APSA-WorldVeg Vegetable Breeding Consortium

By

World Vegetable Center



Proposal Summary

Project title	Developing host resistance to thrips in chilli, a multilateral prebreeding approach	
Submitted to	APSA-WorldVeg Vegetable Breeding Consortium Members	
Main WorldVeg contact person	Mandy Lin (mandy.lin@worldveg.org)	
Main WorldVeg scientists and designation	<ul style="list-style-type: none"> • Derek Barchenger, Scientist - Pepper Breeding • Manoj Kumar Nalla, Scientist - Pepper Breeding • Srinivasan Ramasamy, Lead Entomologist; Interim Deputy Director General - Partnerships; Flagship Program Leader for Safe and Sustainable Value Chains 	
Project duration	5 years (1 July 2024 – 30 June 2029)	
Project fees(US\$)*	600,000	Minimum of 15 companies at 40,000 USD per company (8,000 USD/year)
		Maximum of 30 companies at 20,000 USD per company (4,000 USD/year)

*The participating seed companies will equally share Project fees.

Justification and background

Chilli (*Capsicum annuum*) production is practiced across a broad range of agroecological conditions, including the humid tropics, dry deserts, and cool temperate climates. Irrespective of the production system, chilli growers will almost certainly face some production challenges associated with abiotic and biotic stresses. Pests and pathogens are among the most common causes of reduced productivity in chilli, and thrips are one of the most devastating pests on a global scale. At least 16 species of thrips are pests of chilli, which cause direct damage by feeding on chilli fruits, flowers, and leaves. Feeding on leaves can affect leaf size and carbon allocation in the plant, reduce photosynthetic capacity, and ultimately decrease yields. Bronzing and silvering of the fruit skin, and a subsequent reduction in market quality are consequences of thrips' feeding damage on the fruits. In addition, thrips can also cause indirect damage by serving as vectors for virus transmission through saliva during feeding, with members of *tospovirus* being among the most devastating for chilli production. For instance, five thrips species—namely, *Scirtothrips dorsalis* Hood, *Thrips palmi* Karny, *Thrips tabaci* Lindman, *Frankliniella schultzei* Trybom, and *Ceratothripoides claratris*—have been identified as vectors of tospoviruses in India. These viruses are responsible for causing yield losses ranging from 10 to 60% in various crops, including chilli. Conventional thrips management includes chemical treatments. Unfortunately, this practice does not completely solve the problem caused by thrips and can negatively affect farmers, consumers, and the environment. Thrips-resistant varieties would increase the effectiveness of thrips control and may delay and reduce the

transmission of tospoviruses. Thrips infestation of chilli was particularly damaging in the late kharif season of 2021 across much of Asia due to an outbreak of black thrips (*Thrips parvispinus*), which originated from Thailand, and is recognized as a destructive polyphagous pest that inflicts significant damage to chilli and other solanaceous crops in Indonesia. In response to the severe damage in 2021 and 2022, numerous efforts were made to develop strategies to limit future losses associated with these insects. However, extensive knowledge gaps in the genetic diversity of the Asian thrips population, consistent screening protocols, sources of stable resistance to thrips, understanding the genetic mechanisms of thrips resistance, QTLs, and molecular markers associated with resistance limit approaches to breed chilli that are resistant to this pest. Due to the tremendous damage caused by thrips on a global scale and the overall lack of sources of host resistance, there is a clear need to study host resistance and effective management strategies for chilli production.

Several WorldVeg pepper breeding lines are resistant to thrips under field conditions, which can be exploited further to breed resistant varieties. WorldVeg has screened several hundred *Capsicum* germplasm accessions for resistance to sucking insects and broad mites in the past. Two accessions, namely PBC 145 and C00069, were found to be resistant to pests, including broad mite and thrips, among other insects, under natural field conditions. More recently, WorldVeg conducted a large-scale evaluation of breeding lines from three *Capsicum* species against two-spotted spider mite. The same factors likely condition host resistance for thrips and two-spotted spider mite. We found five lines highly resistant, and a further nine were resistant to two-spotted spider mites (Figure 1). In early 2022 WorldVeg initiated the evaluation of breeding lines from two *Capsicum* species for host resistance to *Thrips palmi* in artificial infestation experiments. The lines evaluated included those previously identified to be resistant to two-spotted spider mites and those found in our field trials in Taiwan and Bangladesh, as well as lines with observed resistance in our field trials in Hyderabad during the devastating 2021 season. This screening identified nine highly resistant lines to thrips, seven of which were also resistant to two-spotted spider mites and one line that was identified as resistant in Hyderabad, indicating some level of broad host resistance mechanism might exist in our sources (Figures 2 and 3). Interestingly, the four most resistant lines in our experiment were members of *C. chinense*.

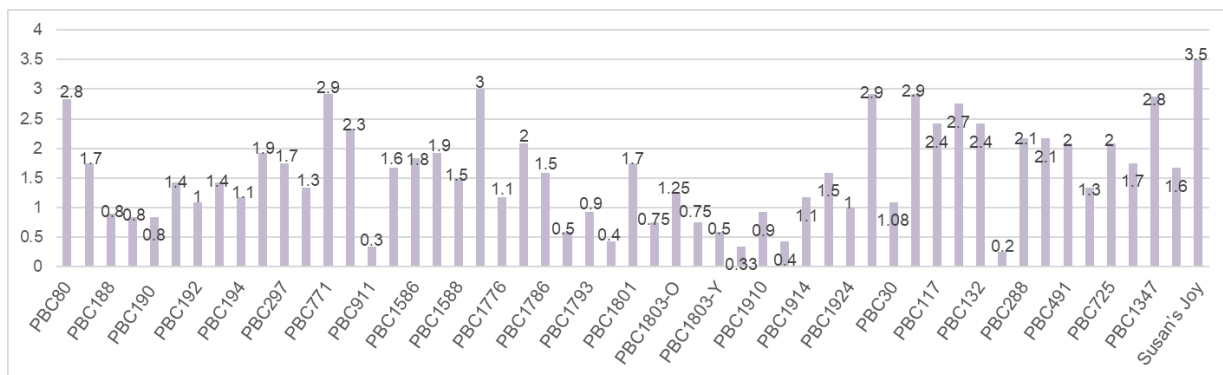

Figure 1. Screening results of diverse WorldVeg breeding lines against two-spotted spider mites as a proxy for thrips tolerance. Susan's Joy = AVPP9905 was the susceptible check.

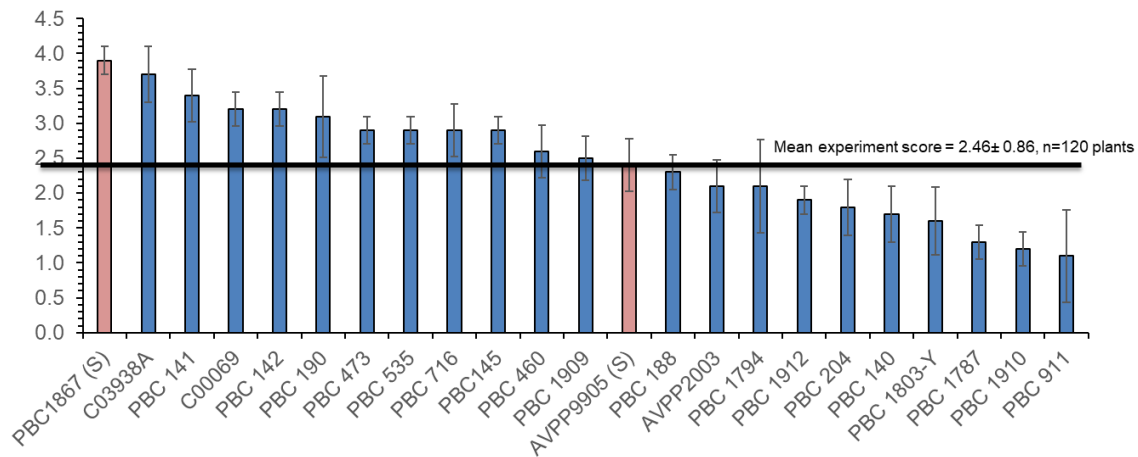

Figure 2. Preliminary results of the two-spotted spider mite-resistant lines, *Scriptothrips dorsalis* tolerant lines identified in Hyderabad, and *Thrips palmi* resistant lines identified in Taiwan and validated in Bangladesh against *Thrips palmi* in Taiwan. AVPP9905 and PBC 1867 were used as putative susceptible checks.

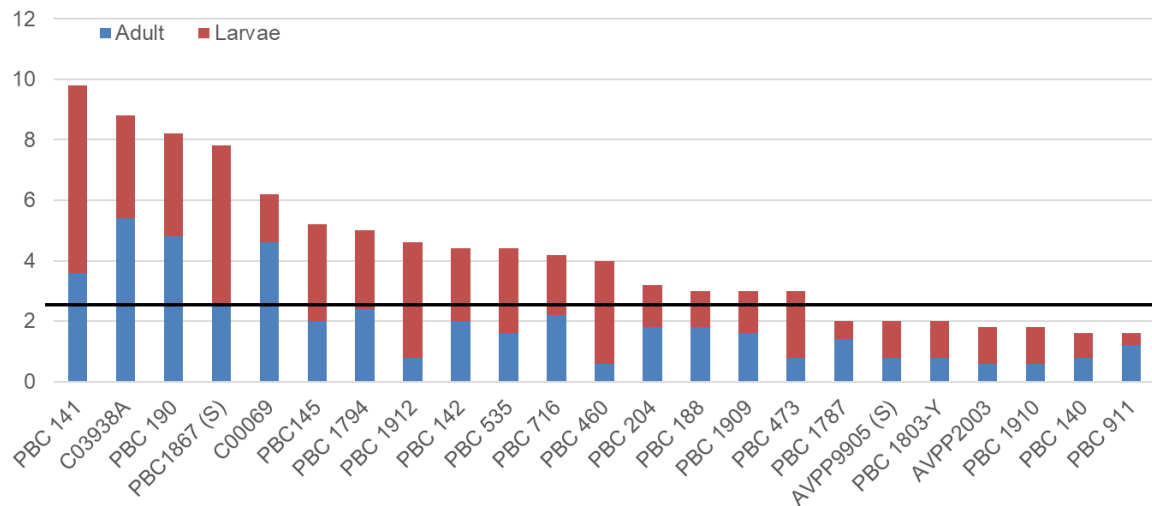

Figure 3. Number of adult and larvae *Thrips palmi* in the apical three leaves of each of the two-spotted spider mite tolerant lines, *Scriptothrips dorsalis* tolerant lines identified in Hyderabad, and *Thrips palmi* resistant lines identified in Taiwan and validated in Bangladesh. AVPP9905 and PBC 1867 were used as putative susceptible checks.

In late 2022 and early 2023, WorldVeg conducted validation screening, with four replications, of the nine most resistant lines identified in our previous experiments compared to a susceptible check. With one exception, all previously identified resistant lines were validated to contain host resistance to thrips

(Figures 4 and 5). The resistant lines were sequenced to establish relatedness and characterize the host resistance factors (Figure 6). As expected, the breeding lines were grouped by species, with members of *C. chinense* forming a clade distinct from the *C. annuum* breeding lines. However, interestingly, the highly resistant breeding lines within each clade were not closely related. This lack of relatedness among the most resistant lines provides a basis for downstream research, as it indicates that different resistance genes may be present and there is potential to pyramid different resistance genes to reach higher resistance levels.

These nine sources of resistance were evaluated under open field conditions at the WorldVeg South and Central Asia regional office in Hyderabad, India. The experiment followed a randomized complete block design (RCBD) with three replications, each with 10 plants. Seeds were sown on 9 August 2023 and transplanted on 17 September 2023. We adhered to all recommended management practices for chilli cultivation, with the exception of insecticide applications. Typically, substantial thrips pressure occurs in the post-rainy season at Hyderabad. Additionally, the prevalence of chilli leaf curl virus (ChILCV; *Begomovirus*) is low during this period, minimizing confounding effects. Based on the observations from the past few years, we selected this sowing window for a clear and comprehensive comparison of thrips resistance and susceptible lines. In addition, we maintained the thrips naturally on chili and brinjal (*Solanum melongena*) under net house conditions. Black thrips were reared on host plants under laboratory conditions and maintained in a net house for mass multiplication. All plants in the three replications were infested twice weekly (except for the first 2 weeks) with the second instar nymph of thrips despite having high natural thrips pressure in the field. This way, we aimed to ensure high thrips infestation pressure in the experiment. We found that the reaction of lines against *T. parvispinus* in Hyderabad differed from that of the reaction against *T. palmi* in Taiwan under controlled conditions. However, PBC 140 (*C. annuum*), PBC 911 (*C. chinense*), PBC 1912 (*C. chinense*), PBC 1787 (*C. chinense*) and AVPP2003 (*C. annuum*) had high levels of tolerance under both conditions, with PBC 140 and PBC 911 standing out as being very tolerant under field conditions (Figure 7). While higher levels of resistance among all nine candidate lines would be preferred, we are aware that tolerance is limited at the moment and strategies to increase this tolerance level to highly resistant are needed for breeding line development.

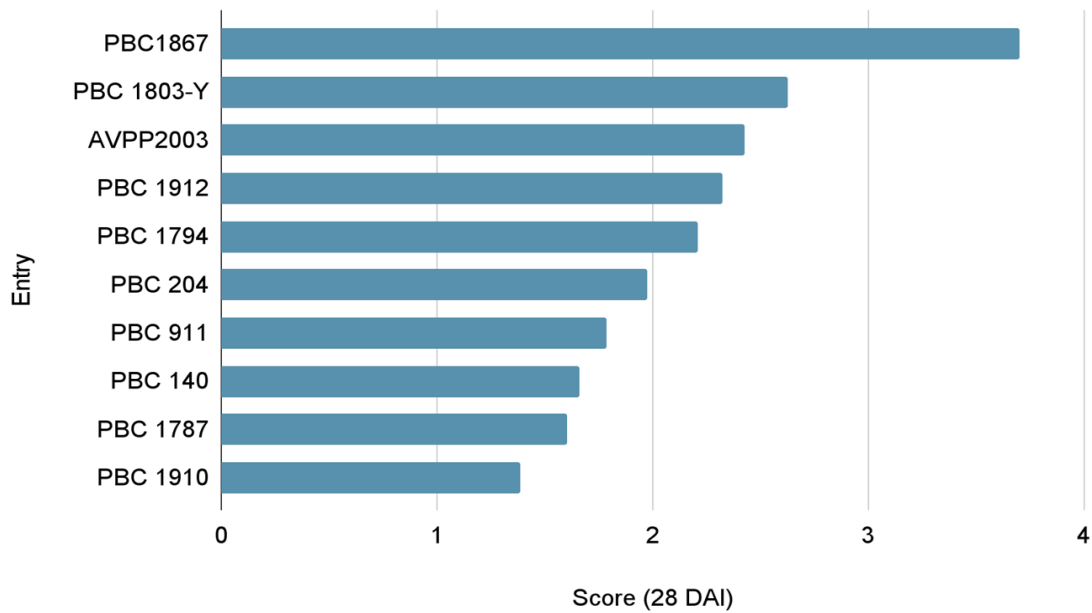

Figure 4. Average severity rating or score of thrips damage of the nine tolerant pepper lines at 28 days after infestation in validation experiment with four replications. PBC 1867 was used as the susceptible check in Taiwan under controlled conditions.

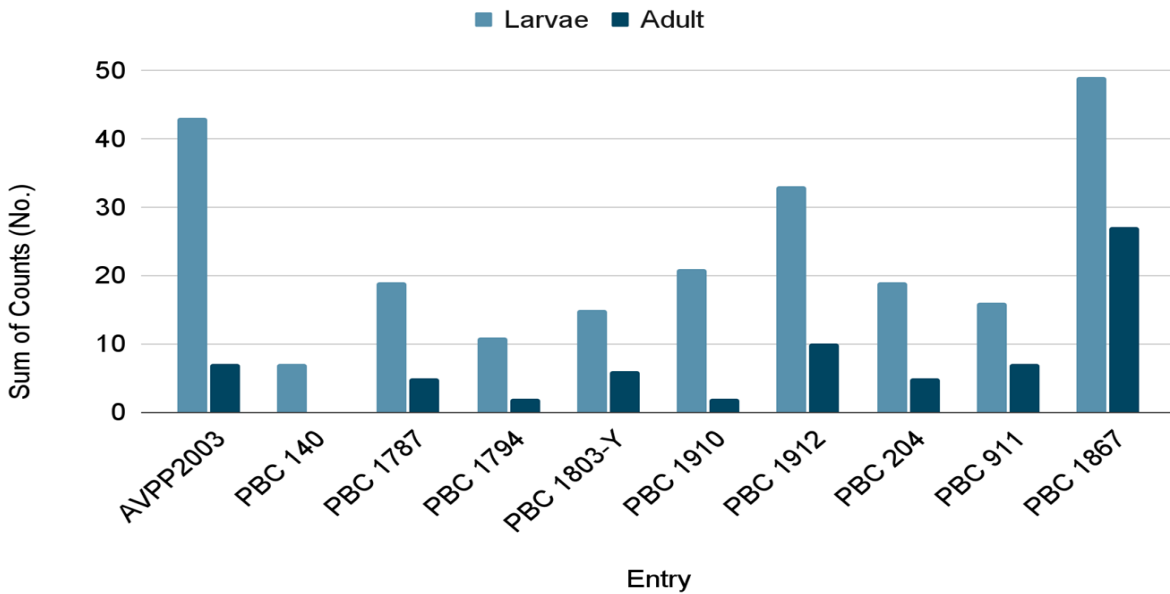

Figure 5. Number of *Thrips palmi* adults and larvae counted in the apical three leaves of the nine identified tolerant lines, and PBC 1867 was used as the susceptible check conducted in Taiwan under controlled conditions.

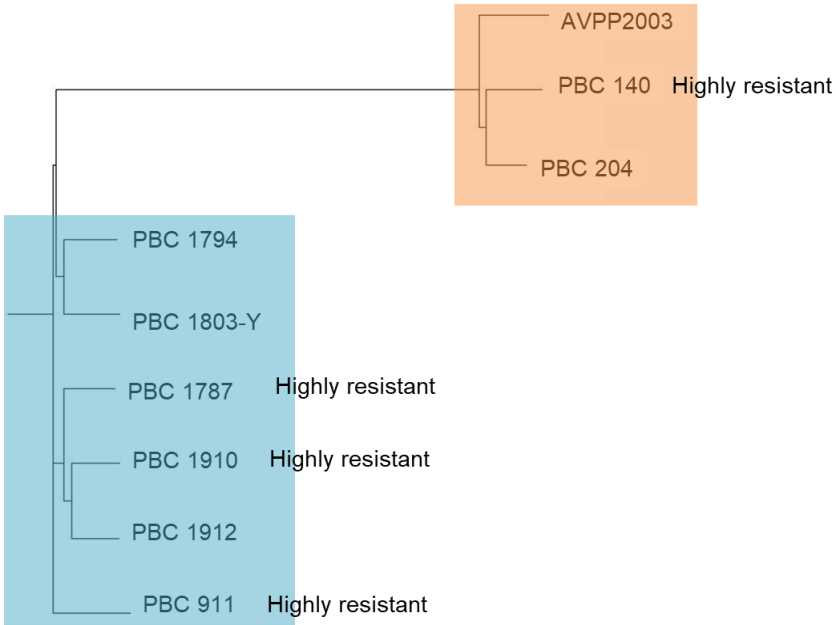

Figure 6. Genetic diversity among the thrips resistance lines developed by WorldVeg. Lines in blue are *Capsicum chinense* and those in orange are *C. annuum*. Sequences were obtained using ddRAD-seq, and diversity analysis was conducted based on 7,072 SNPs.



Figure 7. Representative performance of PBC 140 (left) and PBC 911 (right) in Hyderabad, India, on 29 November 2023.

Given our initial thrips resistance screening results, observations under farmer field conditions, in-depth discussions with the private seed sector, and extensive review of the body of published literature, we have

determined that recurrent selection would be an effective strategy in increasing resistance levels to thrips in chilli, develop mapping populations to identify loci associated with resistance, and to pre-breed sources of high levels of resistance for use in breeding programs. Recurrent selection is a systematic breeding strategy aimed at enhancing the resistance of a plant species to specific stresses or threats, such as thrips. The goal is to gradually enhance specific traits in a population over time, resulting in lines that are better adapted to specific environments, with enhanced productivity, resistance to diseases, or other desirable characteristics. Recurrent selection is particularly effective for enhancing complex traits or traits influenced by multiple genes. The procedures of an effective recurrent program are as follows:

1. Initial evaluation and trait identification: The breeding process begins by assessing the existing genetic diversity within a population or species to identify individuals displaying some level of resistance to the targeted stressor. For instance, plants showing natural resistance are identified in the case of a plant disease.
2. Selection of resistant individuals: Individuals exhibiting the desired resistance traits are selected as parental candidates for the breeding program. These individuals serve as the foundation to improve resistance in subsequent generations.
3. Hybridization: The selected resistant individuals are crossed with other individuals possessing potentially complementary resistance genes and also better adaptation traits (more *C. annuum* background in our case).
4. Selection and evaluation of progeny: Progeny resulting from the crosses are evaluated for the targeted resistance trait. Those displaying the highest resistance level are chosen as parents for the next generation. This selection process ensures the continuous improvement of resistance traits in subsequent generations.
5. Repetition of selection cycles: The selected individuals from each generation become the new parental generation for the next breeding cycle. This repetitive process continues over multiple cycles, with each cycle emphasizing the enhancement and consolidation of resistance traits.

As a basis for a recurrent selection program, in the summer of 2023, WorldVeg screened F1 hybrid progeny derived from selected individuals with the highest levels of tolerance among the individual breeding lines, i.e., we made single plant selection during the validation and preliminary screening of breeding lines, self-pollinated them, and used them for crossing and for downstream screening to reduce the level of segregation. We found that, in general, the severity rating of the F1 progeny was not better than the parents but typically was similar to the mid-parent score (Figure 8). When the F1 hybrid offspring closely mirrors or approximates this midparent value, it suggests a blending or intermediate expression of traits from both parental lines. This similarity can occur due to various genetic mechanisms, including dominant and recessive traits, incomplete dominance, or additive effects of multiple genes influencing the trait. This phenomenon is observed in cases of simple genetic inheritance or when multiple genes contribute additively or interactively to the expression of a particular trait, resulting in an F1 generation that shows traits closely aligned with the midparent value. This result was expected, as resistance to thrips is a multigenic and quantitative trait. Further, it has been previously observed that resistance levels in F1

hybrids are typically not as high as in the most resistant parent in a cross combination. Interestingly, however, was that we found the number of larvae and adults in the apical three leaves to almost always be fewer in the F1 hybrid progeny as compared to the adults (Figure 9). The number of larvae is an important data point because it has been proposed that if a pest finds a host, feeding can occur and symptoms can appear; however, if a pest finds a highly suitable host in addition to feeding and symptoms, reproduction can occur and the presence of larvae can be recorded.

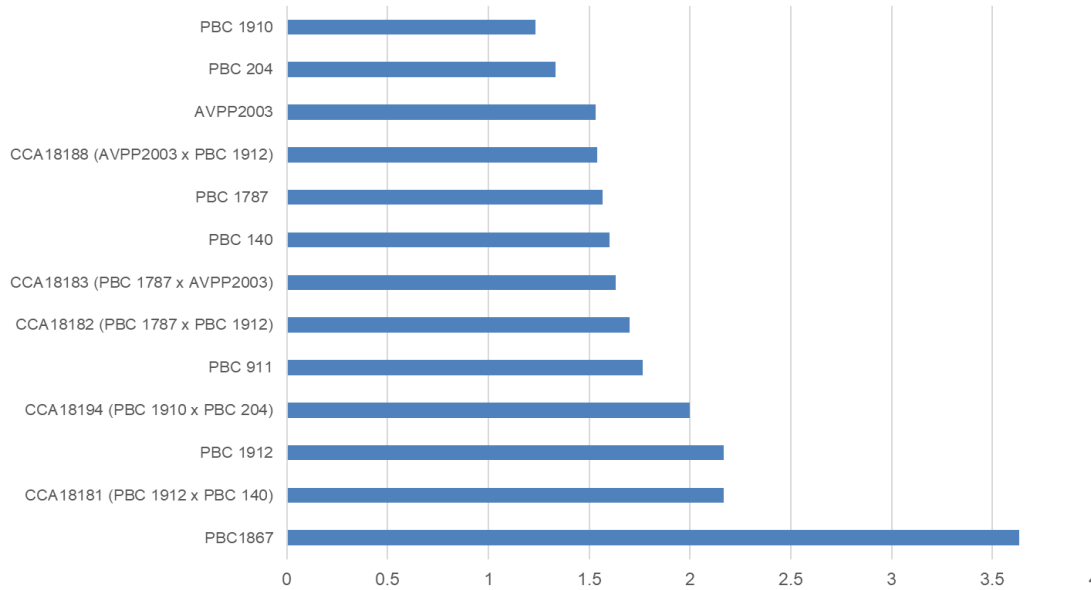

Figure 8. Average severity rating at 28 days after infestation of the nine inbred parental lines and selected F1 hybrid progeny screened against *Thrips palmi* in controlled conditions in Taiwan during July and August 2023. PBC 1867 was used as the susceptible check.

Based on the results obtained so far, we have developed reciprocal double-crosses, which is the true first generation in the recurrent selection program (Table 1). These double hybrid populations will be screened for *T. palmi* resistance in WorldVeg HQ in Taiwan during March 2024 under controlled conditions. The resistant individuals from this screen will be hybridized across families. The resulting progeny will be self-pollinated, and the resulting segregating populations will be screened in late 2024.

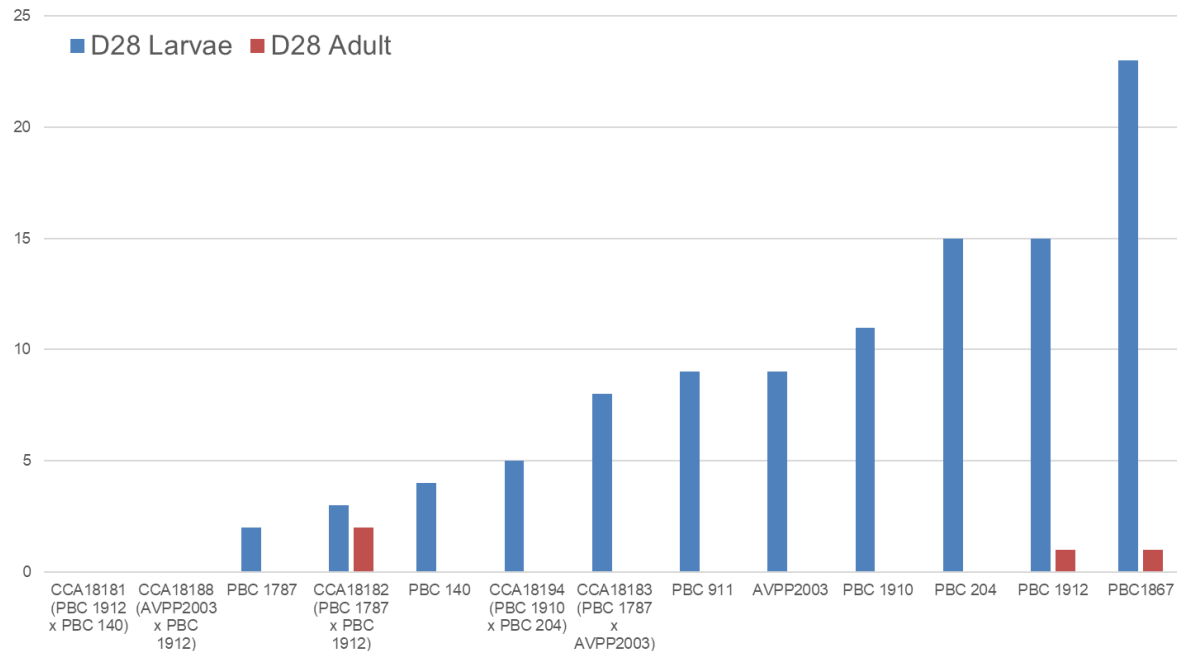

Figure 9. Number of adult and larvae thrips at 28 days after infestation of the nine inbred parental lines and selected F1 hybrid progeny screened against *Thrips palmi* in controlled conditions in Taiwan during July and August 2023. PBC 1867 was used as the susceptible check.

Table 1. Pedigree of the double cross hybrid populations, as the first generation in the recurrent selection program, which will be screened for resistance to *T. palmi* in Taiwan in March 2024.

Entry code	Pedigree code	Pedigree name
CCA18442	CCA18177/ CCA18181	PBC 140/PBC 911//PBC 1912/PBC 140
CCA18443	CCA18181/CCA18177	PBC 1912/PBC 140//PBC 140/PBC 911
CCA18444	CCA18178/CCA18188	PBC 140/PBC 1787//AVPP2003/PBC 1912
CCA18445	CCA18188/CCA18178	AVPP2003/PBC 1912//PBC 140/PBC 1787
CCA18448	CCA18183/CCA18185	PBC 1787/AVPP2003//PBC 1910/PBC 140
CCA18449	CCA18185/CCA18183	PBC 1910/PBC 140//PBC 1787/AVPP2003
CCA18451	CCA18194/CCA18189	PBC 1910/PBC 204//PBC 911/PBC 140

We seek to establish a multilateral project to conduct research to answer some of the critically important and so far, largely neglected questions surrounding thrips resistance, perform recurrent selection to improve thrips tolerance/resistance and map tolerance/resistance genes including information on thrips diversity, to ultimately reduce smallholder farmer losses associated with thrips damage in chilli.

Proposed Activities

1. Characterize the diversity of predominant thrips species in major chilli production regions of India

In this study, thrips will be systematically collected from chilli plants and diverse host plants within the primary chilli production regions of India. The insects will be collected under field conditions to ensure ecological relevance. A few individuals from each population within different crops and locations will be meticulously subjected to morphological identification. The insects will be preserved in 95% ethanol. Subsequently, a judiciously chosen representative sample, comprising 5 to 10 insects from each population, will undergo mitochondrial *cytochrome c oxidase I (coxI)* sequencing. The genetic data obtained from this sequencing will be utilized for both phylogenetic analyses and the evaluation of genetic diversity within and among populations.

2. Distribution of WorldVeg sources of host resistance to thrips for project-member companies for use in pre-breeding

All project members will receive the nine thrips-tolerant sources identified in our research projects, which are the founding members of the recurrent selection program. The material will be made available to seed companies inside India from the WorldVeg SCA office. The nine lines will be made available to companies outside of India from the HQ of WorldVeg in Taiwan. All the nine lines have been multiplied, following the best practices prescribed by WorldVeg, and the seed has been tested for the presence of viroids by the WorldVeg Seed Health and Quarantine Unit and certified as being viroid-free by the Bureau of Animal and Plant Health Inspection and Quarantine of Taiwan. However, additional declarations may be required for some countries (e.g., Thailand, Japan, and Indonesia). Therefore, companies who wish to receive the seed outside of India or Taiwan should register the project as soon as possible, allowing for sufficient time for obtaining phytosanitary permits for seed distribution. Companies who join the project will be provided with AVPP names of the lines and instructions for submitting seed requests, sign the SMTA, and request phytosanitary clearance as soon as possible to facilitate the efficient operation of the project.

The link for submitting seed requests is <https://avrdc.org/seed/seeds/>. For inquiries, please contact Joseph Yu (joseph.yu@worldveg.org and seedrequest@worldveg.org).

3. Multi-location testing of WorldVeg thrips resistance sources to determine broad spectrum and location /species-specific host resistance to thrips in Asia

All member companies are expected to evaluate the nine WorldVeg-provided sources of thrips resistance in selection locations (decided upon at the inception workshop) and return the data to Derek and Manoj (derek.barchenger@worldveg.org and manojkumar.nalla@worldveg.org) within 45 days of the experiment completion. This aspect of the project is essential for the fair and efficient project management. Companies unwilling to provide data from experiments are discouraged from joining the

special project. Selection of trial sites will be agreed upon by a consortium, with the goal to test in as many unique locations as possible, which represent different agroecologies and which are hotspots for the pest. However, host resistance to ChiCLV will be minimal among the nine sources. Therefore, management of whitefly pests is essential for the experiment.

All field-based thrips screening trials will follow the same experimental design: a randomized complete block design with three replications, each with 12 plants. In addition, a WorldVeg-provided susceptible check (PBC 1867 or another line but not AVPP9905), a commercial hybrid resistant check (Yashawini), and up to five anonymized in-house checks are to be included in the experiment. Evaluation of the experiment and severity rating system will be standardized, following the WorldVeg-developed 0 to 6 scale (Table 2 and Figures 10 and 11). All data entry sheets will be developed by WorldVeg and shared with each participating member company.

Table 2. A standardized severity rating system developed by WorldVeg to be followed by each project member company in the company-managed field trials.

Rating	Description
0	No symptoms
1	Terminal 3-4 leaves showing tiny eruptions in the interveinal area, or very tiny eruption on the backside of leaf
2	Terminal 3-4 leaves showing curling along the leaf margin.
3	Severe scarring of the terminal and a few basal leaves, or severe scarring on the abaxial surface of the leaf, but the adaxial surface appears normal (Figure 11)
4	Stunted plants, leaves severely curled and leaf area greatly reduced
5	Plants with no leaves and only stem remaining
6	Plant death

4. Providing additional candidate sources of resistance (*C. chinense* germplasm) for evaluation of thrips resistance in multiple locations

In addition to the nine previously identified sources of tolerance to thrips, WorldVeg will also provide each member company with additional candidate lines to be screened for thrips resistance. We have already identified the important effect on the environment, the thrips species, and the production system that can have an effect on the performance of chilli in response to thrips infestation. Thus, it is not reasonable to think that a single or a few sources of resistance will work across a wide range of environments and in



Figure 10. Representative symptom severity scores of 1, 2, 3, and 4 for thrips symptoms on *C. chinense* (top row) and *C. annuum* (bottom row). Symptom severity of ratings of 0, 5, and 6 are self-explanatory.



Figure 11. Representative symptoms in score 3, where the adaxial surface of the leaf appears normal (left), but the abaxial surface has severe scarring from thrips feeds (right).

a durable manner. Furthermore, relying heavily on a limited number of sources imposes significant selection pressure on the thrips populations. Therefore, a larger panel of diverse breeding lines and germplasm with various levels of resistance to thrips will be provided to each member company to serve as a basis for in-house pre-breeding activity and other research to broaden and diversify the thrips resistance breeding efforts in Asia. A special focus will be on *C. chinense*, especially on materials that has already been genotyped and where some preliminary information on thrips tolerance under some conditions is available.

5. Establish two recurrent selection programs at WorldVeg to increase resistance levels to be used for downstream research and breeding line development

Recurrent selection is a cyclic method of population improvement but does not directly lead to the release of cultivars. The basic steps in a cycle of recurrent selection are intermating, evaluation, and selection.

The goal is to improve the overall performance of the population while maintaining genetic diversity rather than to develop outstanding varieties for immediate use. WorldVeg will establish two recurrent selection breeding programs for thrips resistance in pepper.

- The first recurrent selection program will be based at WorldVeg HQ in Taiwan, using WorldVeg-developed breeding lines. Selection of progeny in the HQ recurrent selection program will be based on low severity and larvae number in the apical three leaves, screened against *T. palmi* under controlled conditions.
- The second recurrent selection program will be conducted at the WorldVeg South and Central Asia (SCA) Regional Office in Hyderabad, where ChiLCV pressure is low and thrips pressure is high. This recurrent selection program will be field-based and supplemented with artificial infestation. Seed companies in India will be invited to nominate thrips-resistant candidate lines or non-CMS-based hybrids with thrips resistance to be included in this recurrent selection. Submission of materials by the partner companies is not a requirement, but the benefit of including sources of resistance from the member companies is that the genome-wide association studies at the end of the recurrent selection program will include the genetics from the company facilitating better marker-assisted selection in the individual breeding programs.

The overall procedure of the two recurrent selection programs will be very similar. The differences will be the screening method and the thrips species used for the selection, as outlined below:

- A. In 2022, we screened the base population of diverse sources of tolerance and selected highly resistant individuals, which were self-pollinated. The self-pollinated lines were then screened again in RCBD with three replications.
- B. Selected individuals were hybridized, and the resulting F1 progeny were screened for resistance to thrips in RCBD. The F1 progeny were cross-pollinated, forming double or four-way hybrids.
- C. In early 2024, the four-way hybrids (S1) will be screened for resistance to thrips in family rows. The most resistant individuals will be selected and hybridized across families, and the resulting progeny will be self-pollinated, forming S2 populations.
- D. The S2 populations will be screened in family rows against thrips in late 2024. The most resistant individuals will be selected and hybridized across families, and the resulting progeny will be self-pollinated, forming S3 populations.
- E. In 2025, the S3 populations will be screened in family rows for resistance to thrips. The most resistant individuals will be selected and hybridized across families. The resulting progeny will be self-pollinated, forming S4 populations, and these S4 lines will be self-pollinated. Depending on the performance of the material, the S4 population will serve as the population for pairwise GWAS (activity 6), and selected individuals in the S4

populations with the highest levels of resistance will be used to develop segregating populations (resistant by susceptible) for standard QTL mapping and validation.

6. Pairwise genome-wide association studies (GWAS) to map loci significantly associated with resistance to thrips in pepper

Approximately 1,000 individual plants derived from the two recurrent selection programs (S4 or S5) will be genotyped. After thorough phenotyping, a set of 200 thrips-resistant plants and 200 individuals that are genetically very near to the resistant plants but show a highly susceptible phenotype will be selected for GWAS. Significant associations between genotypes and phenotypes will be identified in the S4 populations. WorldVeg will develop molecular markers for thrips resistance based on these associations. The molecular markers will be provided to each member company and will be validated in segregating populations, developed from biparental populations developed from resistant by susceptible, which are used for QTL mapping and trait marker association.

7. Multi-location testing of a segregating population in India in diverse production locations under protected cultivation screen houses to favor buildup of thrips populations and to limit infestation from other insect pests

Based on data sharing, transparency, and ability to conduct statistically sound experiments in the hot spots for thrips in activity 2, selected project member companies will be provided with recurrent selection S4 population(s) for thrips screening either through artificial infestation in controlled conditions or through hot spot screening in the field. These populations can be used for trait-marker association studies to validate the significant loci associated with resistance and also directly for line development in the breeding program of each company, with the lines with the highest levels of resistance being used for crossing and population development.

8. Workshops, communications, data and information sharing, and project management

For the smooth operation of the project and to provide a strong foundation for success, WorldVeg will 1) create a WhatsApp group for the project members for information exchange and updates, 2) make a google share folder with all project information including protocols, data collection sheets, and other relevant information for the project which will be shared to all members of the project 3) host an in-person inception workshop for project planning and implementation, host annual workshops for the project either in Taiwan, India or Thailand, and host a final workshop to provide an overview the results and develop a plan for the path forward. All project member companies will provide the data for the screening of the populations, the sequence information, the significant loci identified, and the primer sequences for the molecular markers developed in the project, in addition to the sources of resistance (base populations and additional putative sources) and recurrent populations developed. The markers can

be used by each member company for marker-assisted selection and pre-breeding activities, increasing the effectiveness and efficiency of breeding for host-resistant chilli hybrids.

Deliverables

1. Understanding of the thrips population structured in Asia during five years.
2. A base population of nine tolerant sources of resistance provided to each member company for pre-breeding and line development activities.
3. Multi-location evaluation of the nine sources of resistance across Asia and information shared with all member companies, providing a basis for site/environmental-specific and durable thrips resistance in pepper.
4. Additional putative sources of resistance and tolerance to thrips provided to each member company to diverse thrips resistance pre-breeding and line development activities, allowing for sustained thrips resistance long term.
5. Two recurrent selection populations developed, one in Taiwan under controlled conditions and one in India under open field conditions, which will result in increased levels of resistance and provide sources for line development, pre-breeding, and other research activities.
6. Pairwise genome-wide association studies to identify loci contributing to thrips resistance in chilli and development of molecular markers based on significant SNPs.
7. Segregating populations will be provided to project member companies for validation of the GWAS results and use in the breeding program.
8. Clear and effective communication about project status and findings, and molecular markers developed in the project will be provided to each member company for marker-assisted pre-breeding, facilitating efficient host-resistant hybrid development.

Duration and project fees

The project will be conducted from 1 July 2024 to 30 June 2029 with the following fees which will be equally shared by the participating seed companies:

Budget item	Cost (US\$)
Personnel	345,003
Supplies and operations	136,249
Workshops	15,000
Travel	19,212
Indirect costs	84,536
Total	600,000

Timeline of activities

Activity	Year 1		Year 2		Year 3		Year 4		Year 5	
	6	12	18	24	30	36	42	48	54	60
1. Characterize the diversity of predominant thrips species in major chilli production regions of India										
2. Distribution of WorldVeg sources of host resistance to thrips for project-member companies for use in pre-breeding										
3. Multi-location testing of WorldVeg thrips resistance sources to determine broad spectrum and location /species-specific host resistance to thrips in Asia										
4. Providing additional candidate sources of resistance (<i>C. chinense</i> germplasm) for evaluation of thrips resistance in multiple locations										
5. Establish two recurrent selection programs at WorldVeg to increase resistance levels to be used for downstream research and line development breeding										
6. Pairwise genome-wide association studies (GWAS) to map loci significantly associated with resistance to thrips in pepper										
7. Multi-location testing of a segregating population in India in diverse production locations under protected cultivation screen houses to favor buildup of thrips populations and to limit infestation from other insect pests.										
8. Workshops, communications, data and information sharing, and project management										

References

- Bassett, P. 1981. Observations on broad mite *Polyphagotarsonemus latus* (Banks) (Acari: Tarsonemidae) attacking cucumber. Proc. Br. Crop Prot. Conf. Pests Dis.1: 99-103.
- Capinera, J.L. 2001. Order thysanoptera-thrips: Handbook of vegetable pests. Academic Press, San Diego.
- Fery, R.L. and J.M. Schalk. 1991. Resistance in pepper (*Capsicum annuum* L.) to western flower thrips [*Frankliniella occidentalis* (Pergande)]. HortScience 26:1073–1074.
- Gerson, U. 1992. Biology and control of the broad mite, *Polyphagotarsonemus latus* (Banks) (Acari: Tarsonemidae). Exp. Appl. Acarol. 13:163–178.
- Gniffke, P.A., S.C. Shieh, S.W. Lin, Z.M. Sheu, J.R. Chen, F.I. Ho, W.S. Tasi, Y.Y. Chou, J.F. Wang, M.C. Cho, R. Schafleitner, L. Kenyon, A.W. Ebert, R. Srinivasan, and S. Kumar. 2013. Pepper research and breeding at AVRDC-The World Vegetable Center. Proc. XV Eucarpia Meet. Genetics Breeding Capsicum Eggplant. 305-311.
- Grinberg, M., R. Perl-Treves, E. Palevsky, I. Shomer, and V. Soroker. 2005. Interaction between cucumber plants and the broad mite, *Polyphagotarsonemus latus*: From damage to defense gene expression. Entomol. Exp. Appl. 115:135–144.
- Jones, D.R. 2005. Plant viruses transmitted by thrips. Eur. J. Plant Pathol. 113:119–157.
- Kousik, C., B.M. Shepard, R. Hassell, A. Levi, and A.M. Simmons. 2007. Potential sources of resistance to broad mites (*Polyphagotarsonemus latus*) in watermelon germplasm. HortScience 42:1539-1544.
- Lazarre, M. and D. Gerling. 1993. The population dynamics of natural enemies of *Bemisia tabaci* in cotton fields and the influence of insecticide sprays. Phytoparasitica 21:171–172.
- Maharajaya, A., B.Vosman, G. Steenhuis-Broers, A. Harpenas, A Purwito, R.G.F. Visser, and R.E. Voorrips. 2011. Screening of pepper accessions for resistance against two thrips species (*Frankliniella occidentalis* and *Thrips parvispinus*). Euphytica 177:401–410.
- Maharajaya, A., B. Vosman, F. Verstappen, G. Steenhuis-Broers, R. Mumm, A. Purwito, R.G. Visser, and R.E. Voorrips. 2012. Resistance factors in pepper inhibit larval development of thrips (*Frankliniella occidentalis*). Entomol. Exp. Appl. 145:62–71.
- Maris, P.C., N.N. Joosten, R.W. Goldbach and D. Peters. 2003. Restricted spread of tomato spotted wilt virus in thrips-resistant pepper. Phytopathology 93:1223–1227.
- Moritz, G., S. Kumm, and L. Mound. 2004. Tospovirus transmission depends on thrips ontogeny. Virus Res. 100:143–149.
- Reitz, S., E.L. Yearby, J.E. Funderburk, J. Stavisky, M.T. Momol, and S.M. Olson. 2003. Integrated management tactics for *Frankliniella thrips* (Thysanoptera: Thripidae) in field-grown pepper. J. Econ. Entomol. 96:1201–1214.

- Shipp J., X. Hao, A. Papadopoulos, and M. Binns. 1998. Impact of Western Flower Thrips (Thysanoptera: Thripidae) on growth, photosynthesis and productivity of greenhouse sweet pepper. *Sci. Hort.* 78:87–102.
- Simmons, A.M. and D.M. Jackson. 2000. Evaluation of foliar applied insecticides on abundance of parasitoids of *Bemisia argentifolii* (Homoptera: Aleyrodidae) in vegetables. *J. Entomol. Sci.* 35:1–8.
- Talekar, N. 1991. Thrips on pepper: AVRDC's research strategy. Regional Consultation Workshop, Bangkok.
- Tommasini, M. and S. Maini. 1995. *Frankliniella occidentalis* and other thrips harmful to vegetable and ornamental crops in Europe. In: J. Van Lenteren, A.J.M. Loomans, M.G. Tommasini, S. Maini, and J. Ruidavets (eds) Biological control of thrips pests, vol 95. Wageningen University Papers, Wageningen, pp 1–42.
- Ulman, D.E., J.J. Cho, R.F.L. Mau, W.B. Hunter, D.M. Westcot and D.M. Suter. 1992. Thrips-tomato spotted wilt virus interactions: morphological, behavioral and cellular components influencing thrips transmission. *Adv. Dis. Vector Res.* 9:196–240.
- Weintraub, P.G. 2007. Integrated control of pests in tropical and subtropical sweet pepper production. *Pest Manag. Sci.* 63:753–760
- Welter, S.C., J.A. Rosenheim, M.W. Johnson, R.F.L. Mau, and L.R. Gusukumaminuto. 1990. Effects of Thrips-Palmi and Western Flower Thrips (Thysanoptera, Thripidae) on the yield, growth, and carbon allocation pattern in cucumbers. *J Econ Entomol* 83:2092–2101